

# Improvement of the Reliability of the Industrial Electric Networks

M. Bouguerra, I. Habi

**Abstract**—The continuity in the electric supply of the electric installations is becoming one of the main requirements of the electric supply network (generation, transmission, and distribution of the electric energy). The achievement of this requirement depends from one side on the structure of the electric network and on the other side on the availability of the reserve source provided to maintain the supply in case of failure of the principal one. The availability of supply does not only depends on the reliability parameters of the both sources (principal and reserve) but it also depends on the reliability of the circuit breaker which plays the role of interlocking the reserve source in case of failure of the principal one. In addition, the principal source being under operation, its control can be ideal and sure, however, for the reserve source being in stop, a preventive maintenances which proceed on time intervals (periodicity) and for well defined lengths of time are envisaged, so that this source will always available in case of the principal source failure. The choice of the periodicity of preventive maintenance of the source of reserve influences directly the reliability of the electric feeder system. In this work and on the basis of the semi-markovian's processes, the influence of the time of interlocking the reserve source upon the reliability of an industrial electric network is studied and is given the optimal time of interlocking the reserve source in case of failure the principal one, also the influence of the periodicity of the preventive maintenance of the source of reserve is studied and is given the optimal periodicity.

**Keywords**—Semi-Markovians processes, reliability, optimization, industrial electric network.

## I. INTRODUCTION

IT is known that the electric installations are classified on the basis of several criterions, the principal ones are follows:

- Operation mode;
- Nature of the current;
- Voltage and power level;
- Reliability required of their electric feeder system.

According to the last criterion, the electric installations are divided into three categories [2,3].

M. Bouguerra is with Department of Automation and Electrification of the Industrial Processes, Faculty of Hydrocarbons and Chemistry, University of Boumerdes, Algeria (phone: +21324815394; e-mail: m\_ourad59@yahoo.fr).

I. Habi is with Department of Automation and Electrification of the Industrial Processes, Faculty of Hydrocarbons and Chemistry, University of Boumerdes, Algeria (phone: +21324811786; e-mail: habi\_idir@yahoo.fr).

- first category: these installations don't admit any stop (accidental or planned) of their electric feeder system (E.F.S), the stop of the latter has the human death consequence, this is why their EFS must be carried out with two independent sources.

-second category: these installations don't admit any stop (accidental or planned) of their electric feeder system (E.F.S), the stop of the latter has a significant economic consequence, this is why their EFS must be carried out with two independent sources.

-third category: these installations don't have a capital insert in the technological process, they can admit a stop (accidental or planned) of their EFS going up to 24 hours, their EFS are carried out with only one source.

The great majority of the electric installations belong to the first and second category. In order to ensure a high level of reliability of their electric system feeder, two power supply sources are envisaged, one principal, the other of reserve, generally a cold reserve (electric diesel group) [2,3].

The availability of supply does not only depends on the reliability parameters of the both sources (principal and reserve) but it also depends on the reliability of the circuit breaker which plays the role of interlocking the reserve source in case of failure of the principal one. In addition, the principal source being under operation, its control can be ideal and sure, however for the reserve source being in stop, a preventive maintenances which proceed on time intervals (periodicity)  $P_m$  and for well defined lengths of time  $d_m$  are envisaged, so that this source will always available in case of the principal source failure. The choice of the periodicity of preventive maintenance of the source of reserve influences directly the reliability of the electric feeder system. In this work and on the basis of the semi-markovian's processes, the influence of the time of interlocking the reserve source upon the reliability of an industrial electric network is studied and is given the optimal time of interlocking the reserve source in case of failure the principal one, also the influence of the periodicity of the preventive maintenance of the source of reserve is studied and is given the optimal periodicity.

## II. SUGGESTED ALTERNATIVE FOR THE EFS

The suggested alternative for the industrial electric networks can be schematized as follows (Fig. 1):

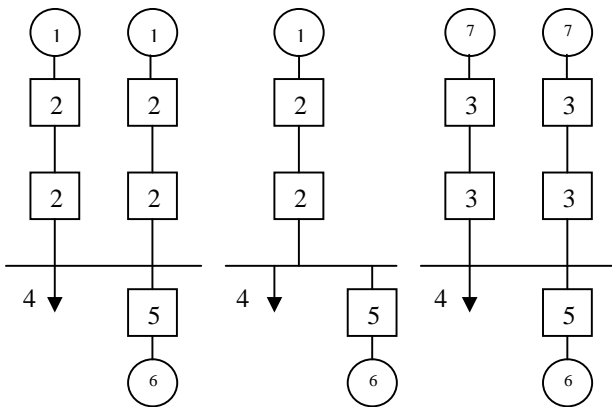

Fig. 1 Standard diagram of the EFS structure

1. external source from the national electric network;
2. circuit breaker of electric line;
3. circuit breaker;
4. electric load
5. circuit breaker for interlocking the reserve source;
6. reserve source;
7. local source ( turbo generator).

III. ELEMENTS AND ELECTRIC FEEDING SYSTEM, NOTIONS AND CLASSIFICATION OF THE FAILURES

At the time of study of reliability, the concept of element and system is relatively conditional. Their difference is carried out on the level of the analysis of the system at the time of the resolution of a problem of reliability posed.

An object considered as element at the time of a study, can be seen as system if the study is directed towards another object of weak scale. As an example, at the time of the modeling of the reliability of an electro energetic system, the lines of electric transport of power are regarded as elements; on the other hand if this study is posed on the same line, the latter is regarded as system made up of several elements, support, insulators, and drivers. At the time of the study of the reliability of the support, this last is presented in the form of a system including several elements: foundation, fitting of fixing.

As elements in the electric feeder systems, we distinguishes the lines, and electric cables, the turbo generators, the transformers and the apparatuses of commutation, the internal part of the EFS is introduced like only one element, if the study is carried out on a greater scale, in particular during the analysis of the effectiveness and the choise of the sources of power supply.

The final goal of the determination of the reliability of various elements and also of the EFS in its globality is related directly to the concept of failure.

We understand by failure of the EFS, the state during which the EFS loses completely or partially its capacity to provide its function, which results in the partial or complete stop of the technological process.

The failures are classified on the basis of several criterions: accidental failure, after wear failure, independent or dependent failure, stable or unstable failure.

An accidental failure is a failure which directly involves the release of the failing element under the action of its electric protection, the failure after wear is a failure bringing the element weakening to a not planed repair. The experiment of exploitation of the EFS showed the low level of the failures after wear and with their weak dangerousity.

The independent failures are failures in which the failure of an element does not involve that of another element, that dependent increases the probability of failure of the other element, in the case of absolute dependence, the failure of the other element is direct and sure, As an example if in an electric switchyard, the failure of a transformer involves the overload of a second transformer, we speak about dependent failure. Let us note that transformers of the EFS are generally calculated and chosen on the basis of 100 % of the load for each one, this is why the failures of transformers are regarded as independent. For the lines with double same circuits if their transport capacity can be unlimited, their failures can not be regarded as independent, very often the rupture of a driver of a circuit can involve with the failure of the other circuit. Also let us note, considering the characteristics of the installations electric of the EFS, the accidental stops are primarily due to stable failures, therefore we will limit ourselves to this type of failure.

The failures of the various elements are at the base of the failures of the EFS, however the reliability of the complex systems as the EFS depend primarily on their structure of the type of connection of the elements and of the dependability of operation of the elements. It is known that from elements of a no high level of reliability, the design of the reliable system can be obtained on the basis of optimal redundant structure, however to expect a great effectiveness of these systems cannot in no case to be assured. In order to locate the weak link of the EFS and its elements, allows to highlight the best means of improvement of their reliability and to determine the source data to ensure the requirements for the reliability of these systems, the first stage to be realized at the time of the study of the reliability of the EFS is the determination and the analysis the reliability of the various elements of these systems.

The information collected on a sample of several industrial electrical networks, located in the north of Algeria allowed us to represent the distribution of the failures of the various elements of these EFS, Table I, to the denominator is indicated the distribution of the failures in percent.

TABLE I  
DISTRIBUTION OF THE FAILURE OF VARIOUS ELEMENTS OF THE EFS IN THE NORTH OF ALGERIA

Electric components	Number of analyzed failures	Number of failures of elements
Power lines	143	Electric drivers(11/7.7), insulators( 132/92.3 )
Transformers	96	Insulators(53/55.2), terminals (31/32.3), switch (12/12.5)

Circuit breakers of line	105	Insulators ( 27/25.7), control drive (58/55.3), system of drive (21/19.0)
Sets of bars	39	Contact with apparatuses (39/100)
Circuit breaker of interlocking of the source of reserve	67	Control devise ( 41/61.2 ), system of drive (26/38.8)
Local source turbo generator	137	System of excitation (28/20.4), mechanicals parts (109/79.6)

IV. BASIC PRINCIPLES, CHOICE AND EVALUATION OF THE PARAMETERS OF RELIABILITY OF THE EFS

The EFS, as any technical system must provide the function for which they are intended. During operation it is essential to have the certainty that these systems function correctly, while preserving their given technical properties. The certainty of correct operation of the EFS is based on the evaluation of the level of reliability required of these systems. In order to solve this problem, the quantitative parameters characterizing their reliability are necessary. The knowledge and the evaluation of these parameters not only make possible to carry out calculations of reliability, but also justify the level of reliability required of the elements of the EFS, to highlight the influence of the reliability of these systems on the effectiveness of operation of the EFS and to choose the optimal structure of the diagrams of these systems.

The great majority of the elements of the EFS are reparable equipment; the principal parameters of reliability of these elements are the failure rate and the average time of repair. In various case, during the study of the reliability of the EFS, several additional parameters of reliability are used, such as: the mean time between failures, the availability factor, the probability of operation, the cost of unavailability of the EFS, however, it is known that all these parameters can be easily determined from the failure rate and the average time of repair. This fact and in order to evaluate the reliability of the EFS, it is necessary to carry out a statistical analysis of the failures of the various elements and to determine their failures rates end the mean time of repair.

The failure rate  $W$  characterizing the frequency of failures is presented in the form of a relationship between number  $n$  of failures observed among  $k$  elements of same type during time  $\Delta t$  [ 4,6 ].

$$W = \frac{n}{k \cdot \Delta t} \tag{1}$$

Generally, we summarize the behaviour of equipment over his lifespan by his curve out of bath-tub [1,7], as presented on Fig. 2.

We generally distinguish on the curve three parts:  
 A: childhood period, the failure rate decreases,  
 B: effective period, the failure rate is constant,

C: period of wear, the failure rate is increases

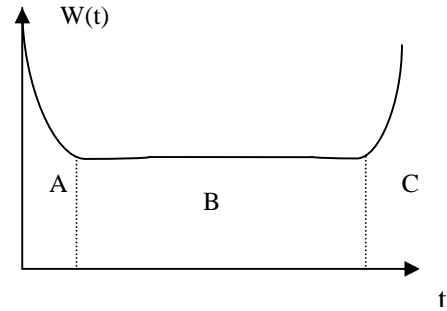

Fig. 2 Curve out of bath-tub of equipment

The evaluation of the frequency of failure on the interval of time  $(t, t + \Delta t)$  can be obtained by the relationship between the number of failing elements  $n$  of the EFS and the total number of elements  $N$  in observation during time  $\Delta t$ .

$$W(t) = \frac{n(t, t + \Delta t)}{[N(t, t + \Delta t) \cdot \Delta t]} \tag{2}$$

Fact and as it is known that  $N(t, t + \Delta t) \neq N(t, t)$ , the equation “refer to (2),” will arise as follows:

$$W(t) = \frac{2n(t, t + \Delta t)}{[N(t, t + \Delta t) + N(t, t)] \Delta t} \tag{3}$$

For the electric lines and cables:

$$W(t) = \frac{2n(t, t + \Delta t)}{[L(t, t + \Delta t) + L(t, t)] \Delta t} \tag{4}$$

$L(t, t), L(t, t + \Delta t)$ : Overall length of the electric lines and cables at the beginning and the end of the period of observation.

Generally during the evaluation of the frequency of failure of the electric equipment, we consider the effective period [ $w(t) = w = \lambda = \text{const}$ ],  $\lambda$  represents the failure rate, owing to the fact that this equipment is suitably developed wish we seldom distinguishes failures and also do not suffer from phenomena of wear[1].

The confidence interval for the failure rate is obtained using the confidence coefficient [6,8]. The higher and lower limits of the failure rate are calculated as follows:

$$\lambda_{\text{sup}} = \frac{\lambda}{v_1} \tag{5}$$

$$\lambda_{\text{inf}} = \frac{\lambda}{v_2} \tag{6}$$

with:

$v_1, v_2$ : parameters dependent on the number  $n$  of failing elements and the probability of confidence [ 8 ].

The average time of repair of the elements of the EFS is estimated by the following relation:

$$T_r = \frac{1}{n} \sum_1^n T_i \quad (7)$$

$$\mu = \frac{1}{T_r} \quad (8)$$

$T_i$  : duration of repair after appearance of failure,  
 $\mu$  : rate of repair.

The failure rate and the average repair time of the elements of the EFS determined with a probability of confidence  $\alpha = 0.95$  are represented on the Table II.

TABLE II  
 PARAMETERS OF RELIABILITY OF THE ELEMENTS OF THE EFS IN NORTH OF ALGERIA

Elements of EFS	Failure rate 1/year			Average time of repair(h)
	$\lambda_{inf}$	$\lambda$	$\lambda_{sup}$	
Electric lines on 100km (kV) :				
- 30	1.20	2.20	3.12	5.6
- 60	1.90	2.00	3.98	5.6
- 220	0.38	1.40	2.58	6.5
Transformers (kV)				
5.5 : 10	0.012	0.023	0.038	70
- 30	0.009	0.018	0.030	90
- 60	0.010	0.020	0.033	100
- 220	0.003	0.020	0.062	100
Disjoncteurs de lignes (kV)				
5.5 : 10				
- 30	0.003	0.005	0.007	10
- 60	0.002	0.005	0.008	10
- 220	0.002	0.005	0.008	10
	0.003	0.020	0.062	24
Electric cables on 100 km (kV)				
5.5 : 10	1.80	2.50	3.37	12
Turbogenerator	3.84	5.80	7.83	70
Sets of bars (kV)				
5.5 : 10	0.003	0.010	0.020	4
- 30	0.011	0.030	0.062	4
- 60	0.005	0.030	0.090	4
- 220	0.007	0.040	0.125	6

V. DETERMINATION OF THE OPTIMAL TIME OF INTERLOCKING OF THE RESERVE SOURCE

The structures of the E.F.S (Fig. 1) can be schematized with their reliability parameters as follows (Fig. 3):

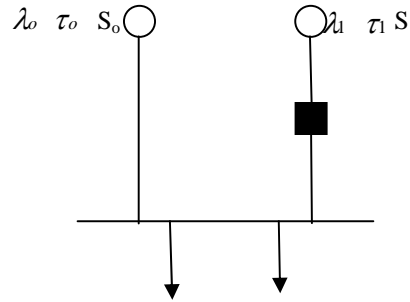

Fig. 3 Representative sources diagram

$S_o$ : principal source;

$S_1$  : reserve source;

$\lambda_o, \tau_o$  : principal source failure rate and time of repair respectively;

$\lambda_1, \tau_1$  : reserve source failure rate and time of repair respectively.

The failure rate and the time of repair of the elements in series are given as follows [9]:

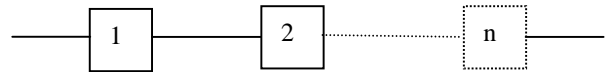

$$\lambda = \sum_{i=1}^n \lambda_i \quad (9)$$

$$\tau = \frac{\sum_{i=1}^n \lambda_i \tau_i}{\sum_{i=1}^n \lambda_i} \quad (10)$$

The failure rate and the time of repair of the elements in parallels are given as follows [9]:

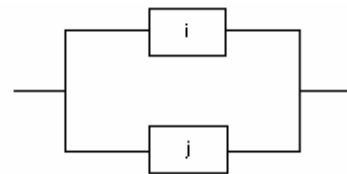

$$\lambda_{ij} = \lambda_i \lambda_j (\tau_i + \tau_j) \quad (11)$$

$$\tau_{ij} = \frac{\tau_i \tau_j}{\tau_i + \tau_j} \quad (12)$$

Under operation, the EFS can have several states, on the basis of the semi-Markovian's processes [5,10,11], the evolution of the EFS operation can be described by the states and the probability of transition  $P_{ij}$  according Fig. 4.

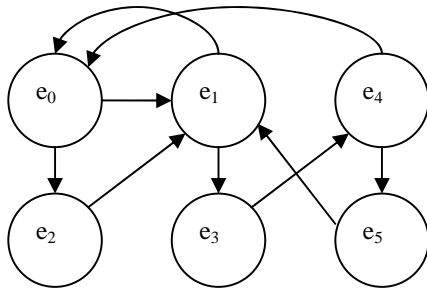

Fig. 4 Semi-Markovian's processes and transitions graph

$e_0$ : PS under operation, RS in reserve;  
 $e_1$ : PS in repair, RS under operation;  
 $e_2$ : PS in failure,  $t_{encl} > t_{adm}$ ;  
 $e_3$ : PS in repair, RS in failure;  
 $e_4$ : PS under operation, RS in repair;  
 $e_5$ : PS in failure, RS in repair.

where:

PS: principal source;

RS, reserve source;

$t_{encl}$ : time of interlocking of the reserve source;

$t_{adm}$ : acceptable time limits of interlocking of the reserve source.

The random values of the MTBF (middle time between failure)  $\xi_0, \xi_1$  as well the repair time  $\eta_0, \eta_1$  of the principal source and the reserve source respectively follow an exponential law [2,3],  $P_i(t), G_i(t)$  with the parameters  $\lambda_i, \mu_i$  ( $i = 0, 1$ ).

The calculation probability  $P_{ij}$  of transitions between states could be calculated as follows:

$$P_{01} = 1 - q \quad (13)$$

$$P_{02} = q \quad (14)$$

$q$ : probability of failure of the circuit breaker of interlocking the reserve source.

The failure of the circuit breaker of interlocking of the reserve source is the state when the time of interlocking  $t_{encl}$  is higher than the acceptable time supported by the industrial technological process  $t_{adm}$ . The time  $t_{encl}$  includes the clean time of operation of the circuit breaker and the time of starting of the reserve source if the latter is a local source (diesel electric group) or more time of interlocking of the circuit breaker of line of the national electric network if the line is the source of reserve.

$$q = P(t_{encl} > t_{adm}) = 1 - F_{encl}(t_{adm}) \quad (15)$$

$$\text{For } t_{encl} = \text{const and } D(t) = P(t_{adm} < t) = \frac{t - t_{admmin}}{t_{admmax} - t_{admmin}} \quad (16)$$

$$q = \int_0^{\infty} [1 - F_{encl}(t)] dD(t) = \frac{t_{encl} - t_{admmin}}{t_{admmax} - t_{admmin}} \quad (17)$$

where:

$F_{encl}(t)$ : distribution law of the random value  $t_{encl}$ ;

$D(t)$ : distribution law of the random value  $t_{adm}$ .

$$P_{10} = P\{\eta_0 < \xi_1\} = \int_0^{\infty} G_0(t) dR(t) = \frac{\mu_0}{\lambda_1 + \mu_0} \quad (18)$$

$$P_{13} = P\{\eta_0 > \xi_1\} = \int_0^{\infty} [1 - G_0(t)] dR(t) = \frac{\lambda_1}{\lambda_1 + \mu_0} \quad (19)$$

$$P_{40} = P\{\xi_0 > \eta_1\} = \int_0^{\infty} [1 - R_0(t)] dG_1(t) = \frac{\mu_1}{\lambda_0 + \mu_1} \quad (20)$$

$$P_{45} = P\{\xi_0 < \eta_1\} = \int_0^{\infty} R_0(t) dG_1(t) = \frac{\lambda_0}{\lambda_0 + \mu_1} \quad (21)$$

$$P_{21} = P_{34} = P_{51} = 1 \quad (22)$$

Knowing the existence distribution law  $T_{ij}(t)$  in the state  $e_i$  at the time of the transition to the state  $e_j$  we determine the existence distribution law  $F_i(t)$  and the existence mean time  $T_{ei}$  at the state  $e_i$  as follows:

$$F_i(t) = \sum_{j=0}^n P_{ij} T_{ij}(t) \quad (23)$$

$$T_{ei} = \int_0^{\infty} t dF_i(t) \quad (24)$$

where:

$$T_{01}(t) = P\{\xi_0 < t / t_{encl} < t_{adm}\} = 1 - e^{-\lambda_0 t} \quad (25)$$

$$T_{02}(t) = 1 - e^{-\lambda_0 t} \quad (26)$$

$$T_{21}(t) = P\{t_{encl} - t_{adm} < t\} = \frac{t}{t_{admmax} - t_{admmin}} \quad (27)$$

$$T_{10}(t) = P\{\eta_0 < t / \eta_0 < \xi_1\} = 1 - e^{-(\mu_0 + \lambda_1)t} \quad (28)$$

$$T_{13}(t) = P\{\xi_1 < t / \xi_1 < \eta_0\} = 1 - e^{-(\mu_0 + \lambda_1)t} \quad (29)$$

$$T_{34}(t) = P\{(\eta_0 - \xi_1) < t / \eta_0 > \xi_1\} = 1 - e^{-\mu_0 t} \quad (30)$$

$$T_{40}(t) = P\{\eta_1 < t / \eta_1 < \xi_0\} = 1 - e^{-(\mu_1 + \lambda_0)t} \quad (31)$$

$$T_{45}(t) = P\{\xi_0 < t / \eta_1 > \xi_0\} = 1 - e^{-(\mu_1 + \lambda_0)t} \quad (32)$$

$$T_{51}(t) = P\{\eta_1 < t\} = 1 - e^{-\mu_1 t} \quad (33)$$

The time  $T_{ei}$  at states are equal to:

$$T_{e0} = \frac{1}{\lambda_0}; T_{e1} = \frac{1}{\mu_0 + \lambda_1}; T_{e2} = t_{encl} - \frac{t_{admmax} + t_{admmin}}{2}$$

$$T_{e3} = \frac{1}{\mu_0}; T_{e4} = \frac{1}{\mu_1 + \lambda_0}; T_{e5} = \frac{1}{\mu_1} \quad (34)$$

The stationary probabilities  $P_i$  of occupation at the state  $e_i$  can be given by solving the following system:

$$P_i = \sum_{j \in e} P_{ji} \cdot P_j$$

$$\sum_{i=0}^5 P_i = 1 \quad (35)$$

$$P_0 = P_{10} \cdot P_1 + P_{40} \cdot P_4 \quad (36)$$

$$P_1 = P_{01} \cdot P_0 + P_{21} \cdot P_2 + P_{51} \cdot P_5 \quad (37)$$

$$P_2 = P_{02} \cdot P_0 \quad (38)$$

$$P_3 = P_{13} \cdot P_1 \quad (39)$$

$$P_4 = P_{34} \cdot P_3 \quad (40)$$

$$P_5 = P_{45} \cdot P_4 \quad (41)$$

$$P_0 + P_1 + P_2 + P_3 + P_4 + P_5 = 1 \quad (42)$$

We determine that :

$$P_0 = \frac{\mu_0(\lambda_0 + \mu_1) + \mu_1 \lambda_1}{(\lambda_0 + \mu_1)[2(2\lambda_1 + \mu_0) + q\mu_0] + q\mu_1 \lambda_1} = \frac{\mu_0(\lambda_0 + \mu_1) + \mu_1 \lambda_1}{K}$$

$$P_1 = \frac{\mu_0(\lambda_0 + \mu_1) + \mu_1 \lambda_1}{K}$$

$$P_2 = \frac{q[\mu_0(\lambda_0 + \mu_1) + \mu_1 \lambda_1]}{K}$$

$$P_3 = P_4 = \frac{\lambda_1(\lambda_0 + \mu_1)}{K}$$

$$P_5 = \frac{\lambda_0 \lambda_1}{K} \quad (43)$$

The mean time between failures (MTBF) of the EFS can be obtained as follows [5]

$$MTBF = \frac{\sum_{e_n \in e^+} P_{e_n} \cdot T_{e_n}}{\sum_{i \in e^+, j \in e^-} P_i \cdot P_{ij}} \quad (44)$$

where:

- $P_{e_n}$  : stationary probability at state  $e_n$
- $T_{e_n}$  : average time of occupation at state  $e_n$
- $e^+$  : states of good functioning of system
- $e^-$  : failure's states of system.

So we determine that:

$$MTBF = \frac{(\lambda_0 + \mu_1) + (\lambda_1 + \mu_0)(1 + \mu_1 / \lambda_0)}{q[\mu_0(\lambda_0 + \mu_1) + \mu_1 \lambda_1] + \lambda_1(2\lambda_0 + \mu_1)} \quad (45)$$

The time of repair  $T_r$  of the E.F.S in case of failure is calculated as follows [5]:

$$T_r = \frac{\sum_{e_n \in e^-} P_{e_n} \cdot T_{e_n}}{\sum_{i \in e^+, j \in e^-} P_i \cdot P_{ij}} \quad (46)$$

We determine that:

$$T_r = \frac{q[\mu_0(\lambda_0 + \mu_1) + \mu_1 \lambda_1] T_{e2} + \lambda_1(\lambda_0 + \mu_1) / \mu_0 + \lambda_0 \lambda_1 / \mu_0}{q[\mu_0(\lambda_0 + \mu_1) + \mu_1 \lambda_1] + \lambda_1(2\lambda_0 + \mu_1)} \quad (47)$$

We notice that for  $q = 0$ , circuit breaker of interlocking the reserve source absolutely reliable and for  $\lambda_0 = \lambda_1 = \lambda$  and  $\mu_0 = \mu_1 = \mu$ , we find the well-known formulas of the MTBF and  $T_r$  for an EFS with two sources of power supply.

$$MTBF = \frac{1}{\lambda} \left(1 + \frac{\mu}{\lambda}\right) \quad (48)$$

$$T_r = 1 / \mu \quad (49)$$

Generally at the time of the exploitation of the EFS, we carry out planned repairs of the electric components of these systems. This is why the evolution of the EFS on the basis of semi-Markovian process is represented as follows Fig. 5:

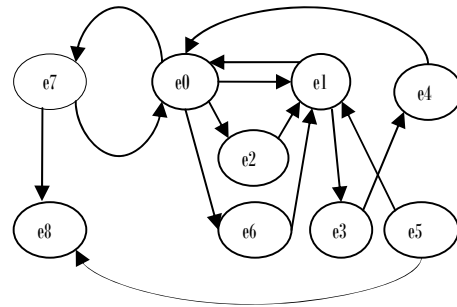

Fig. 5 Semi-Markovian Processes, graph of transitions between states, taking account of the planned repair of the elements of the EFS

- $e_0$ : PS under operation, RS in reserve ;
- $e_1$ : PS in repair, RS under operation ;
- $e_2$ : PS in failure,  $t_{encl} > t_{adm}$ ;
- $e_3$ : PS in repair, RS in failure;
- $e_4$ : PS under operation, RS in repair;
- $e_5$ : PS in failure, RS in repair ;
- $e_6$ : PS in failure, RS in planned repairs ;
- $e_7$ : PS in planned repairs, RS under operation;

$e_8$  : PS in planned repairs, RS in failure.

In this case, the following assumptions are taken into account: The mean time between failures  $\xi_0^a$  of the principal source as of the source of reserve  $\xi_1^a$  follows an exponential law with the parameters  $\lambda_0^a$  and  $\lambda_1^a$  respectively. The periodicities of planned maintenance  $\theta_0^p$  and  $\theta_1^p$  of the principal source and the source of reserve are at constant time,  $\theta_0^p = \theta_1^p = \text{const}$ .

The durations of planned maintenance  $T_0^p$  and  $T_1^p$  of the principal source and the source of reserve are regarded as known. The average time of planned repair or accidental repair of the principal source and the source of reserve follow an exponential law with the parameters  $\mu_0^a, \mu_0^p, \mu_1^a, \mu_1^p$  respectively. If one of the sources is failing during the planned maintenance of the other source, we proceed directly to an accelerated repair of the latter, the time of accelerated planned repair follows an exponential law with the parameters  $\mu_0^{pa}, \mu_1^{pa}$  for the principal source and the source of reserve respectively.

In this case the probabilities  $P_{ij}$  of transition of the semi-markovian models (Fig. 5) are formulated as follows:

$$P_{01} = (1 - \gamma_0) (1 - \gamma_1) (1 - q) \tag{50}$$

$$P_{02} = (1 - \gamma_0) (1 - \gamma_1) q \tag{51}$$

$$P_{06} = (1 - \gamma_0) \gamma_1 \tag{52}$$

$$P_{07} = \gamma_0 \tag{53}$$

Where:

$$\gamma_0 = \frac{T_0^p}{T_{ann}} : \text{Probability that the principal source is in planned repair}$$

$$\gamma_1 = \frac{T_1^p}{T_{ann}} : \text{Probability that the source of reserve is in planned repair.}$$

$$q = P \{t_{encl} > t_{adm}\}$$

$$P_{10} = \frac{\mu_0^a}{\lambda_1^a + \mu_0^a} \tag{54}$$

$$P_{13} = \frac{\lambda_1^a}{\lambda_1^a + \mu_0^a} \tag{55}$$

$$P_{40} = \frac{\mu_1^a}{\lambda_0^a + \mu_1^a} \tag{56}$$

$$P_{43} = \frac{\lambda_0^a}{\lambda_0^a + \mu_1^a} \tag{57}$$

$$P_{70} = \frac{\mu_0^p}{\lambda_1^a + \mu_0^p} \tag{58}$$

$$P_{78} = \frac{\lambda_1}{\lambda_1 + \mu_0^p} \tag{59}$$

$$P_{21} = P_{34} = P_{51} = P_{61} = P_{84} = 1 \tag{60}$$

The average times of occupation at state  $e_i$  are given “refer to (24),”

We determine that :

$$\begin{aligned} T_{e0} &= \frac{1}{\lambda_0^a}; T_{e1} = \frac{1}{\lambda_1^a + \mu_0^a}; T_{e2} = t_{encl} - \frac{t_{admmax} + t_{admmin}}{2}; \\ T_{e3} &= \frac{1}{\mu_0^a}; T_{e4} = \frac{1}{\lambda_0^a + \mu_0^a}; T_{e5} = \frac{1}{\mu_1^a}; \\ T_{e6} &= \frac{1}{\mu_1^{pa}}; T_{e7} = \frac{1}{\lambda_0^a + \mu_0^p}; T_{e8} = \frac{1}{\mu_0^{pa}} \end{aligned} \tag{62}$$

The analytical resolution of system “refer to (35),” for the determination of the stationary probabilities of the Markovian semi process, becomes in this case complex, this is why and in order to calculate these probabilities, we used the software Matlab, which gave the results for the MTBF according to  $t_{adm}/t_{encl}$  as follows Fig. 6.

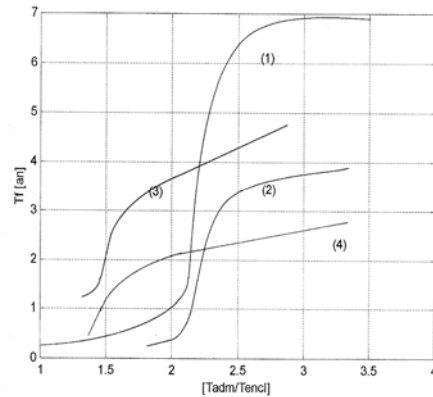

Fig. 6 Mean time between failures (MTBF) of the EFS according to  $t_{adm}/t_{encl}$

where:

-1.  $T_{encl} = 3 \text{ min}$ ,  $\lambda_0^a = 0.00034 \text{ 1/h}$

-2.  $T_{encl} = 3 \text{ min}$ ,  $\lambda_0^a = 0.00068 \text{ 1/h}$ ;

-3.  $T_{encl} = 5 \text{ min}$ ,  $\lambda_0^a = 0.00034 \text{ 1/h}$ ;

-4.  $T_{encl} = 5 \text{ min}$ ,  $\lambda_0^a = 0.00068 \text{ 1/h}$ ;  $T_0^p = 50 \text{h}$ ;  $T_1^p = 150 \text{h}$

## VI. DETERMINATION OF THE OPTIMAL PREVENTIVE MAINTENANCE OF THE RESERVE SOURCE

The principal source being under operation, its control can

be ideal and sure, however for the reserve source being in stop, a preventive maintenance which proceeds on time intervals (periodicity)  $P_m$  and for well defined lengths of time  $d_m$  are envisaged, so that this source will always available in case of the principal source failure. The choice of the periodicity of preventive maintenance of the source of reserve influences directly the reliability of the electric feeder system.

Under operation, the EFS can has several states, on the basis of the semi-Markovian processes [5,10,11], the evolution of the EFS operation can be described by the states and the the probability of transitions  $P_{ij}$  according to fig.7

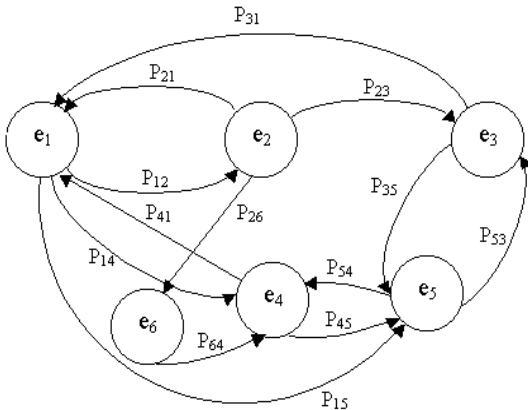

Fig. 7 Semi-Markovian process states and transitions graph

- $e_1$  : PS under operation, RS in reserve;
  - $e_2$  : PS under operation, RS in preventive maintenance;
  - $e_3$  : PS under operation, RS in repair;
  - $e_4$  : RS under operation, PS in repair;
  - $e_5$  : PS and RS in repair;
  - $e_6$  : SR is started.
- PS: principal source, RS: reserve source.

The random values of the good functioning,  $\xi_0, \xi_1$  as well as the repair time  $\eta_0, \eta_1$  of the principal source and reserve source respectively follow an exponential law [4]  $P(t)$  and  $G(t)$  with the parameters  $\lambda_i, \mu_i$  ( $i = 0, 1$ ). The reserve source failure rate is taken equal to  $\alpha\lambda_1$  with

$$0 < \alpha < 1.$$

We suppose that the reserve source interlocking in the event of the principal source failure is absolutely reliable, the reserve source starting is immediate.

The transitions probability  $P_{ij}$  could be calculated as follows:

$$P_{12} = P\{\xi_0 > P_m\} = e^{-\lambda_0 P_m}$$

$$P_{14} = P\{\xi_0 < P_m\} \cdot P\{\xi_1 > P_m\} = (1 - e^{-\lambda_0 P_m}) \cdot e^{-\alpha\lambda_1 P_m}$$

$$P_{15} = P\{\xi_0 < P_m\} \cdot P\{\xi_1 < P_m\} = (1 - e^{-\lambda_0 P_m}) \cdot (1 - e^{-\lambda_1 P_m})$$

$$P_{21} = P\{\xi_1 > P_m\} \cdot P\{\xi_0 > d_m\} = e^{-(\lambda_0 d_m + \alpha\lambda_1 P_m)}$$

$$P_{23} = P\{\xi_1 < P_m\} = (1 - e^{-\alpha\lambda_1 P_m})$$

$$P_{26} = P\{\xi_1 > P_m\} \cdot P\{\xi_0 < d_m\} = e^{-\alpha\lambda_1 P_m} (1 - e^{-\lambda_0 d_m})$$

$$P_{31} = P\{\xi_0 > \eta_1\} = \int_0^{\infty} [1 - P_0(t)] dG_1(t) = \frac{\mu_1}{\lambda_0 + \mu_1}$$

$$P_{35} = P\{\xi_0 < \eta_1\} = \int_0^{\infty} P_0(t) dG_1(t) = \frac{\lambda_0}{\lambda_0 + \mu_1}$$

$$P_{41} = P\{\eta_0 < \xi_1\} = \int_0^{\infty} G_0(t) dP_1(t) = \frac{\mu_0}{\mu_0 + \alpha\lambda_1}$$

$$P_{45} = P\{\eta_0 > \xi_1\} = \int_0^{\infty} [1 - G_0(t)] dP_1(t) = \frac{\alpha\lambda_1}{\mu_0 + \alpha\lambda_1}$$

$$P_{53} = P\{\eta_0 < \eta_1\} = \int_0^{\infty} G_0(t) dG_1(t) = \frac{\mu_0}{\mu_0 + \mu_1}$$

$$P_{54} = P\{\eta_1 < \eta_0\} = \int_0^{\infty} G_1(t) dG_0(t) = \frac{\mu_1}{\mu_0 + \mu_1}$$

$$P_{64} = 1 \tag{63}$$

where:

$P_m$  : periodicity of preventive maintenance of the source of reserve;

$d_m$  : time duration of the preventive maintenance;

$P$  : probability;

$\lambda_0, \lambda_1$  : failure rate of the principal and reserve source respectively;

$\mu_0, \mu_1$  , repair rate of the principal and reserve source respectively,

$\xi_0, \xi_1$  : random time of good functioning of the principal and reserve source respectively,

$\eta_0, \eta_1$  : repair random time of the principal and reserve source respectively,

$P_0(t), P_1(t)$  : failure law distribution of the principal and reserve source respectively,

$G_0(t), G_1(t)$  : repair law distribution of the principal and reserve source respectively.

The average time  $T_{ei}$  of occupation at state  $e_i$  could be calculated as follows :

$$T_{e1} = E \min\{\xi_0, P_m\} = \int_0^{P_m} [1 - P_0(t)] dt = \frac{1 - e^{-\lambda_0 P_m}}{\lambda_0} \tag{64}$$

$$T_{e2} = E \min\{\xi_0, d_m\} = \int_0^{d_m} [1 - P_0(t)] dt = \frac{1 - e^{-\lambda_0 d_m}}{\lambda_0} \tag{65}$$

$$T_{e6} = 0 \text{ (the reserve source starting is immediate.)} \tag{66}$$

where:

E: expected valued.



For the other states, knowing the existence distribution law  $T_{ij}(t)$  in the state  $e_i$  at the time of the transition to the state  $e_j$ , we determine the law of distribution  $F_i(t)$  and the existence mean time at the state  $e_i$ ,  $T_{ei}$  as follows:

$$F_i(t) = \sum_{j=0}^n P_{ij} T_{ij}(t) \tag{67}$$

$$T_{ei} = \int_0^{\infty} t dF_i(t) \tag{68}$$

where:

$$T_{31}(t) = P\{\eta_1 < t / \eta_1 < \xi_0\} = 1 - e^{-(\mu_1 + \lambda_0)t} \tag{69}$$

$$T_{35}(t) = P\{\xi_0 < t / \eta_1 > \xi_0\} = 1 - e^{-(\mu_1 + \lambda_0)t} \tag{70}$$

$$T_{41}(t) = P\{\eta_0 < t / \eta_0 < \xi_1\} = 1 - e^{-(\mu_0 + \alpha\lambda_1)t} \tag{71}$$

$$T_{45}(t) = P\{\xi_1 < t / \eta_0 > \xi_1\} = 1 - e^{-(\mu_0 + \alpha\lambda_1)t} \tag{72}$$

$$T_{53}(t) = P\{\eta_0 < t / \eta_0 < \eta_1\} = 1 - e^{-(\mu_0 + \mu_1)t} \tag{73}$$

$$T_{54}(t) = P\{\eta_1 < t / \eta_1 < \eta_0\} = 1 - e^{-(\mu_0 + \mu_1)t} \tag{75}$$

We determine that:

$$T_{e3} = \frac{1}{\mu_1 + \lambda_0}, T_{e4} = \frac{1}{\mu_1 + \alpha\lambda_1}, T_{e5} = \frac{1}{\mu_1 + \mu_0} \tag{76}$$

The stationary probabilities  $P_i$  of occupation at the state  $e_i$  can be given by solving the equations system according to:

$$\begin{cases} P_i = \sum_{j \in e} P_{ij} \cdot P_j \\ \sum_{i=1}^6 P_i = 1 \end{cases}$$

$$\begin{aligned} P_1 &= P_{21} \cdot P_2 + P_{31} \cdot P_3 + P_{41} \cdot P_4 \\ P_2 &= P_{12} \cdot P_1 \\ P_3 &= P_{23} \cdot P_2 + P_{53} \cdot P_5 \\ P_4 &= P_{14} \cdot P_1 + P_{54} \cdot P_5 + P_{64} \cdot P_6 \\ P_5 &= P_{15} \cdot P_1 + P_{35} \cdot P_3 + P_{45} \cdot P_4 \\ P_6 &= P_{26} \cdot P_2 \end{aligned}$$

The mean time between failures system (EFS) can be obtained as follows:

$$T_f = \frac{\sum_{e_n \in e^+} P_{e_n} \cdot T_{e_n}}{\sum_{i \in e^+, j \in e^-} P_i \cdot P_{ij}}$$

where :

- $P_{en}$  : stationary probability at state  $e_n$  ;
- $T_{en}$  : average time of occupation at state  $e_n$  ;
- $e^+$  : states of good functioning of system;

$e^-$  : failure's states of system.

The mean time between failures variation curve obtained according to the ratio  $P_m/d_m$  is as follows Fig.8):  $d_m=8$  h.

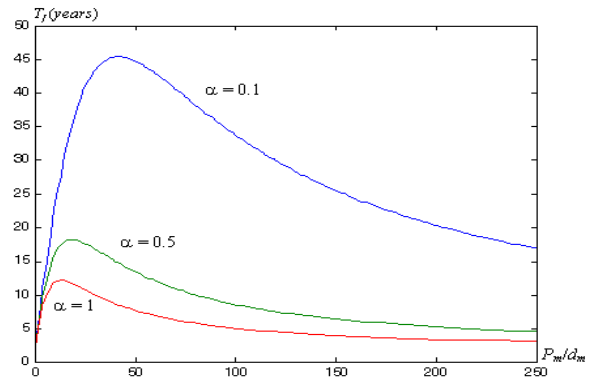

Fig. 8 mean time between failures variation according to ration  $Pm/dm$ .

## VII. CONCLUSION

The analysis of resulted obtained allows establishing the following conclusions:

The parameters of reliability of the EFS influence particularly over the mean time between failures of the EFS. The influence over the mean repair time is practically negligible what is explained by the high values of the failure rates of the two sources of power supply. The principal parameters of reliability of the influential EFS over the mean time between failures are the failure rate of the principal source and the  $tadm/tencl$  report/ratio. Not to take into account, the frequency and the duration of planned repairs of the sources involves an increase in the mean time between failures of the EFS going of 1.5 to 2 times. The influence of the report/ratio  $tadm/tencl$  over the mean time between failures of the EFS is appreciable. As example, for  $tencl = 3$  min,  $\lambda_0^g = 0.00068$  1/h and  $tadm/tencl = 2.2$ , the mean time between failures is equal  $Tf = 1$  year (Fig. 6, curve. 2). In order to increase  $Tf$  by two time it is necessary to decrease by two time the failure rate of the principal source (curve.1) or to increase the ratio by 2.2 to 2.4, the practice of exploitation of the RAE showed that the increase in this report/ratio can be obtained easily and with a negligible cost. The optimal interval of the report/ratio for an appreciable increase in the time of correct operation of the EFS ranges between 1.5 and 3.

An optimal periodicity of preventive maintenance of the reserve source has been found which corresponds to the maximum time between failures of the system.

An optimal periodicity of preventive maintenance of the source of reserve can be explained as follows: a great periodicity of preventive maintenance of the source of reserve has a consequence a great probability of having a failure of this source so we have a reduction in the mean time between failures, for a weak periodicity the probability to have a failure of the principal source during a preventive

maintenance of the source of reserve is significant so we have a reduction of the mean time between failures of the system.

#### ACKNOWLEDGMENT

Our thanks go for the department of distribution of the electric power of Boumerdes and Algiers (sonelgaz) for their assistance, in particular on the statistical data of failures of the electric components.

#### REFERENCES

- [1] Aupied J., Retour d'expérience appliqué à la sûreté de fonctionnement des matériels en exploitation, 1994.
- [2] Bouguerra M. "Analyse des variantes des réseaux d'alimentation électrique des stations de compression de gaz", *revue viniti*, n°9, 1987, P. 109-111.
- [3] Bouguerra M., Benouareth A., "Optimal rebulding of the electric feeder system of the gas compressors plants", *ICEEC'04, cairo*, 2004, p. 849-851.
- [4] Gnedenko B.V., Beliaev Y. K., méthodes mathématiques en fiabilité, Moscou, Mir, 1972.
- [5] Korolok V., Tourbine A., Processus semi markoviens et leur application, Kiev, 1976.
- [6] Mikhailov B.B., Fiabilité des systèmes d'alimentation électrique des entreprises industrielles, Moscou, 1973.
- [7] Pages A., Goudran M., Fiabilité des systèmes, 1980.
- [8] Rozanov M. N.; Fiabilité des systèmes electroenergetiques, Moscou, 1974.
- [9] Ventsel H., théorie des probabilités, Mir, Moscou, 1973.
- [10] Wang W., Loman J., " Reliability/ availability of K-out of N system with standby unit", *proceeding of the annual reliability and maintainability symposium*, 2002.
- [11] Kaufman A. , Grouchy D., Druon R. Modeles mathematiques pour l'étude de la fiabilité des systemes. Masson et Cie, 1975.

**Mourad Bouguerra** was born in 1959. He received the PhD degree from the institute of petrol and gas, Goupkina/ Moscow in 1988. He is with the department of automation and electrification , university of boumerdes, Algeria as an assistant professor . His main areas of research interest are reliability and optimization of electric network.

**Idir Habi** was born in 1959. He received the Doctorate degree from the national institute polytechnic of Lorraine, Nancy, France in 1987. He is with the department of automation and electrification, university of boumerdes, Algeria as an assistant professor. His main areas of research interest are reliability of automation in power system.